

F-Theta f=254mm

Drawing No. SH-10,6-48-175-254-14

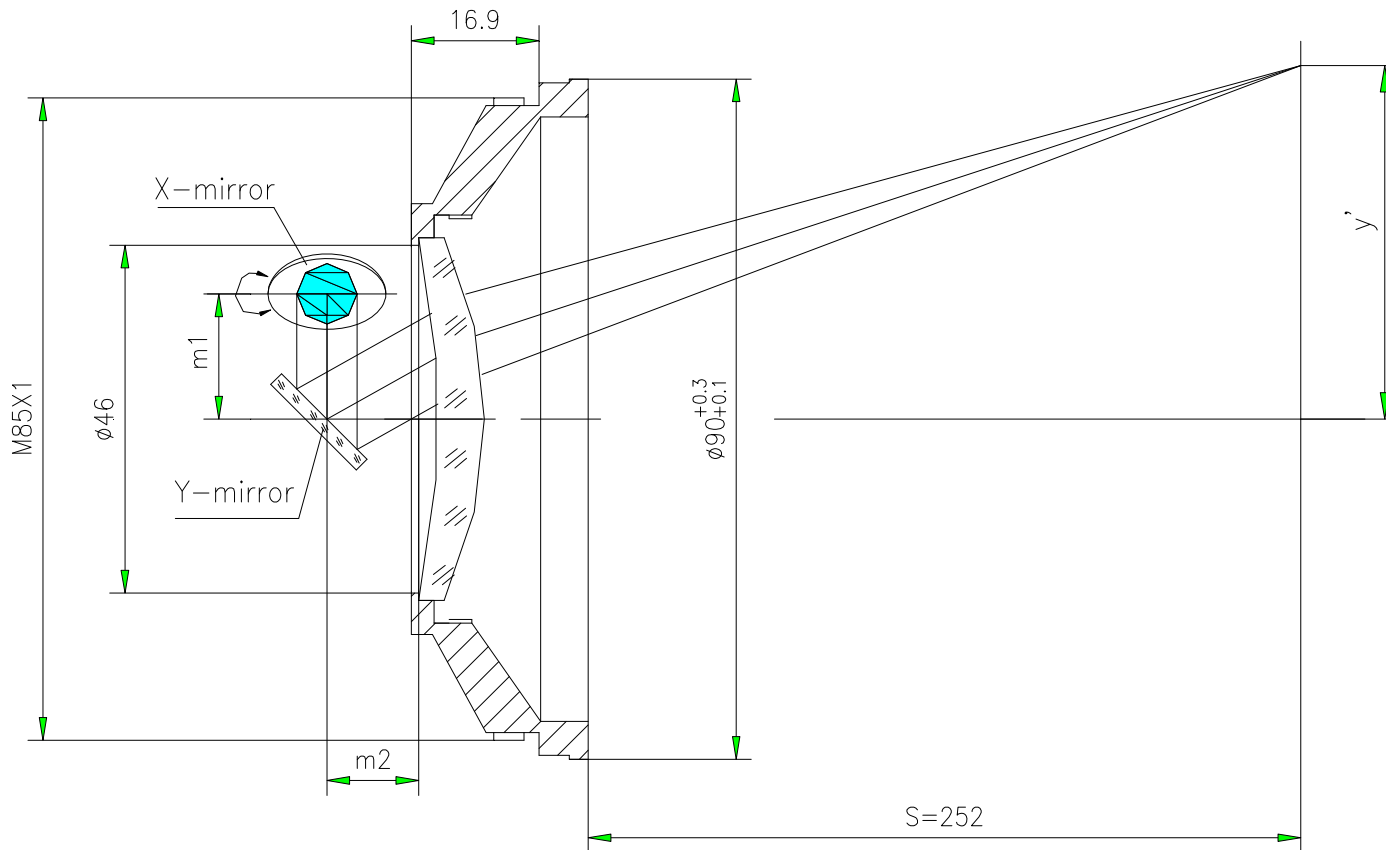

Specification

EFL	254mm
S	252mm
Wavelength	$\lambda = 10,6 \mu\text{m}$
scan angle	$\pm 28^\circ$
max scan field	175mm x 175mm
Entrance beam diameter \varnothing	14mm
Center point diameter ($1/e^2$)	370 μm
Edge point diameter ($1/e^2$)	430 μm
mirror distance m1	16-20
mirror distance m2	10-12
Transmission >	97%
Thread	M85x1