

F-Theta f=580mm

Drawing No. SH79-1064-400-580-20

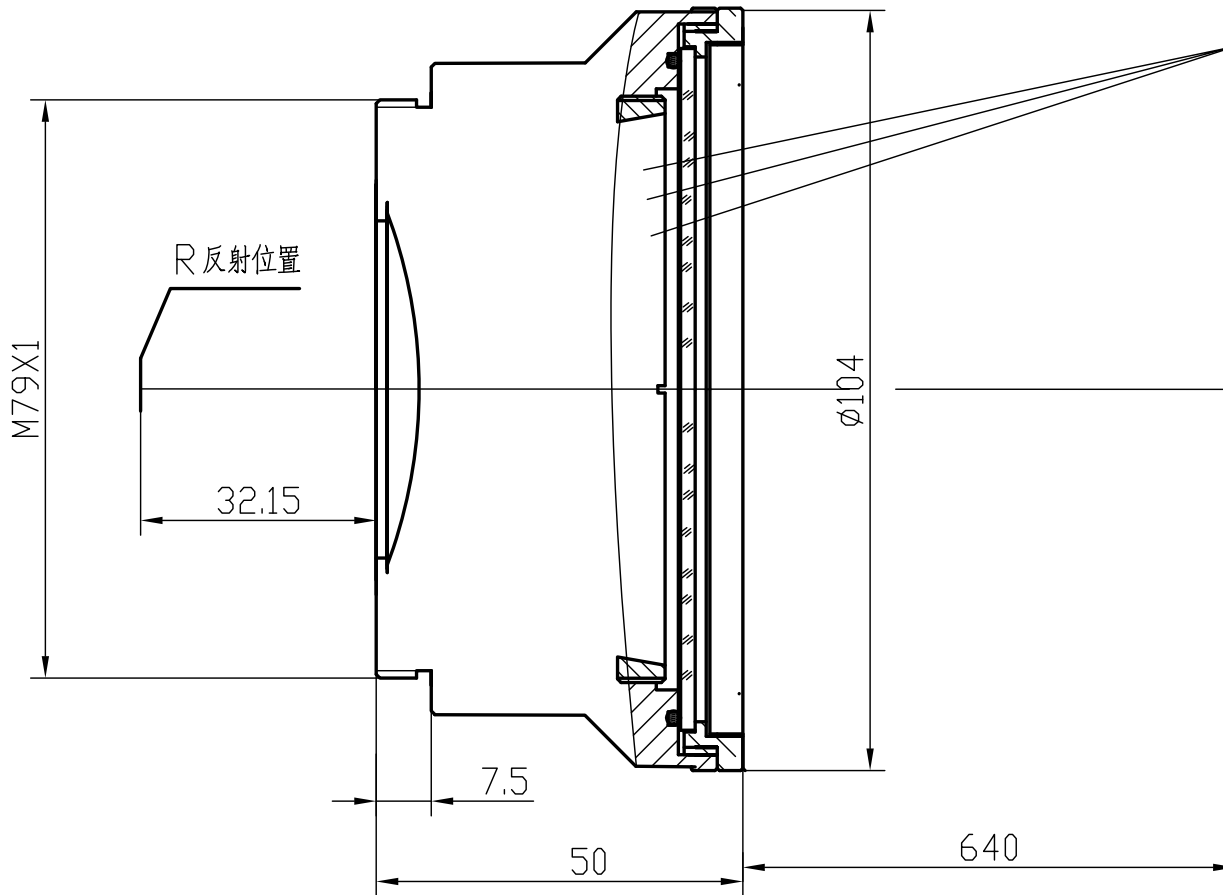

Specification

EFL	580mm
S	640mm
Wavelength	$\lambda = 1064\text{nm}$
scan angle	$\pm 28^\circ$
max scan field	400mm x 400mm
Entrance beam diameter \varnothing	20mm
Center point diameter ($1/e^2$)	57 μm
Edge point diameter ($1/e^2$)	59 μm
mirror distance m1	18
mirror distance m2	18
Transmission >	98%
Thread	M79x1
With protective window	yes