

# F-Theta f=500mm

## Drawing No. SH79-1064-360-500-20

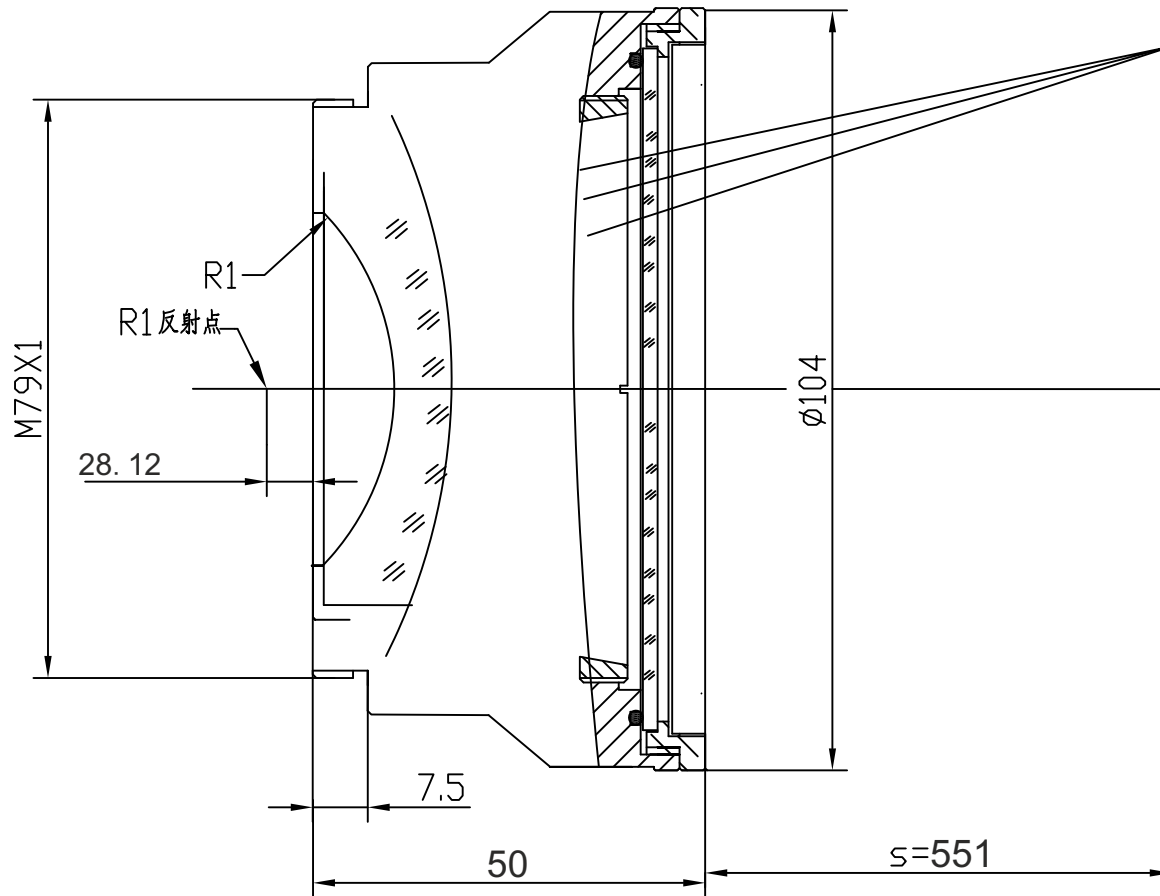

### Specification

EFL	500mm
S	551mm
Wavelength	$\lambda = 1064\text{nm}$
scan angle	$\pm 28^\circ$
max scan field	360mm x 360mm
Entrance beam diameter $\varnothing$	20mm
Center point diameter ( $1/e^2$ )	49 $\mu\text{m}$
Edge point diameter ( $1/e^2$ )	51 $\mu\text{m}$
mirror distance m1	18
mirror distance m2	24
Transmission >	98%
Thread	M79x1
With protective window	yes