

F-Theta f=100mm D20mm for clean

Drawing No. SH-CL-1064-70-100-20-FS

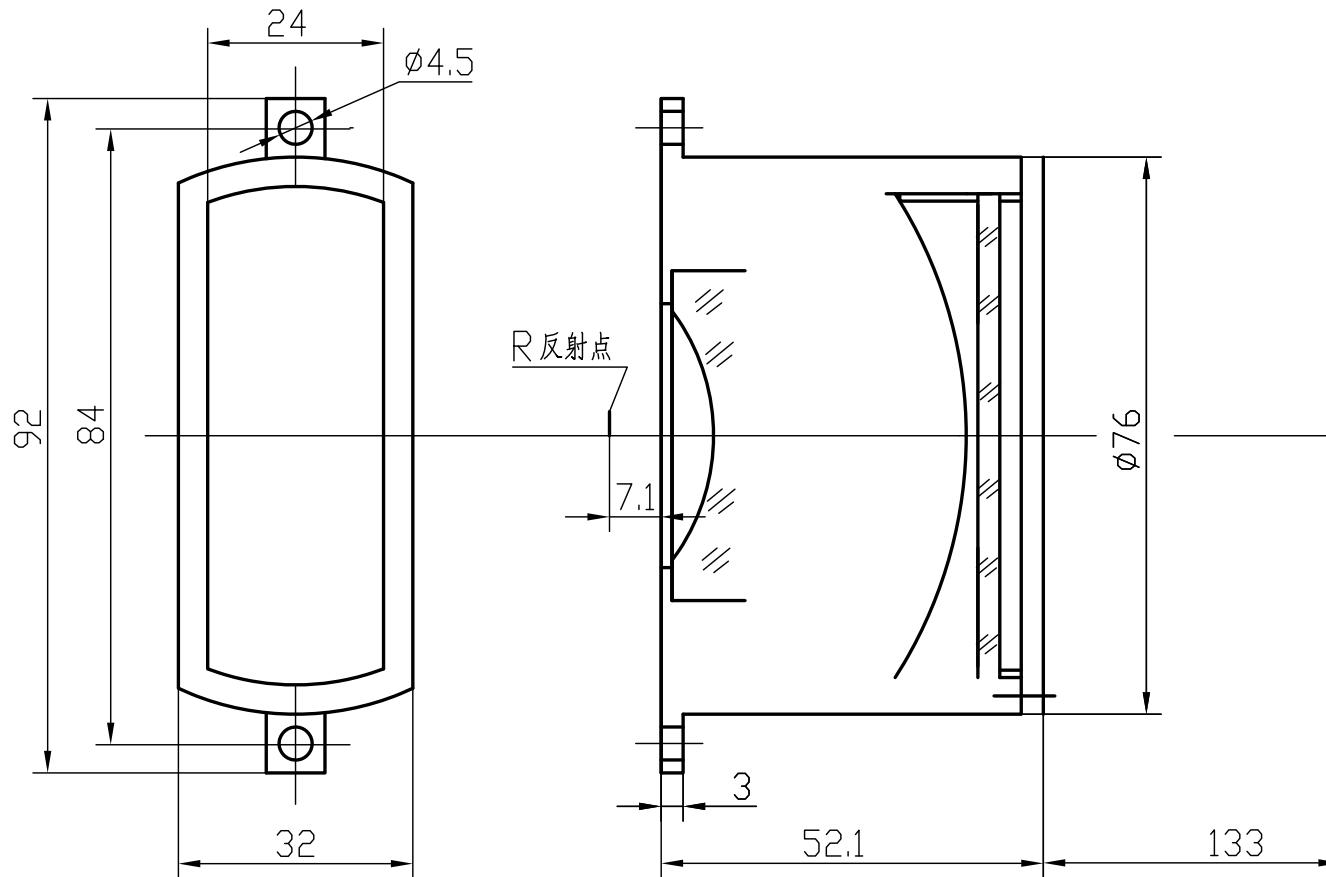

Specification

EFL	100mm
S	133mm
Wavelength	$\lambda = 1064\text{nm}$
scan angle	$\pm 28^\circ$
max scan length	70mm
Entrance beam diameter ϕ	20mm
Center point diameter ($1/e^2$)	16 μm
Edge point diameter ($1/e^2$)	17 μm
mirror distance m1	
mirror distance m2	16-20
Transmission >	97%
Thread	
With protective window	yes