

F-Theta f=420mm

Drawing No. SH-355-300-420-8

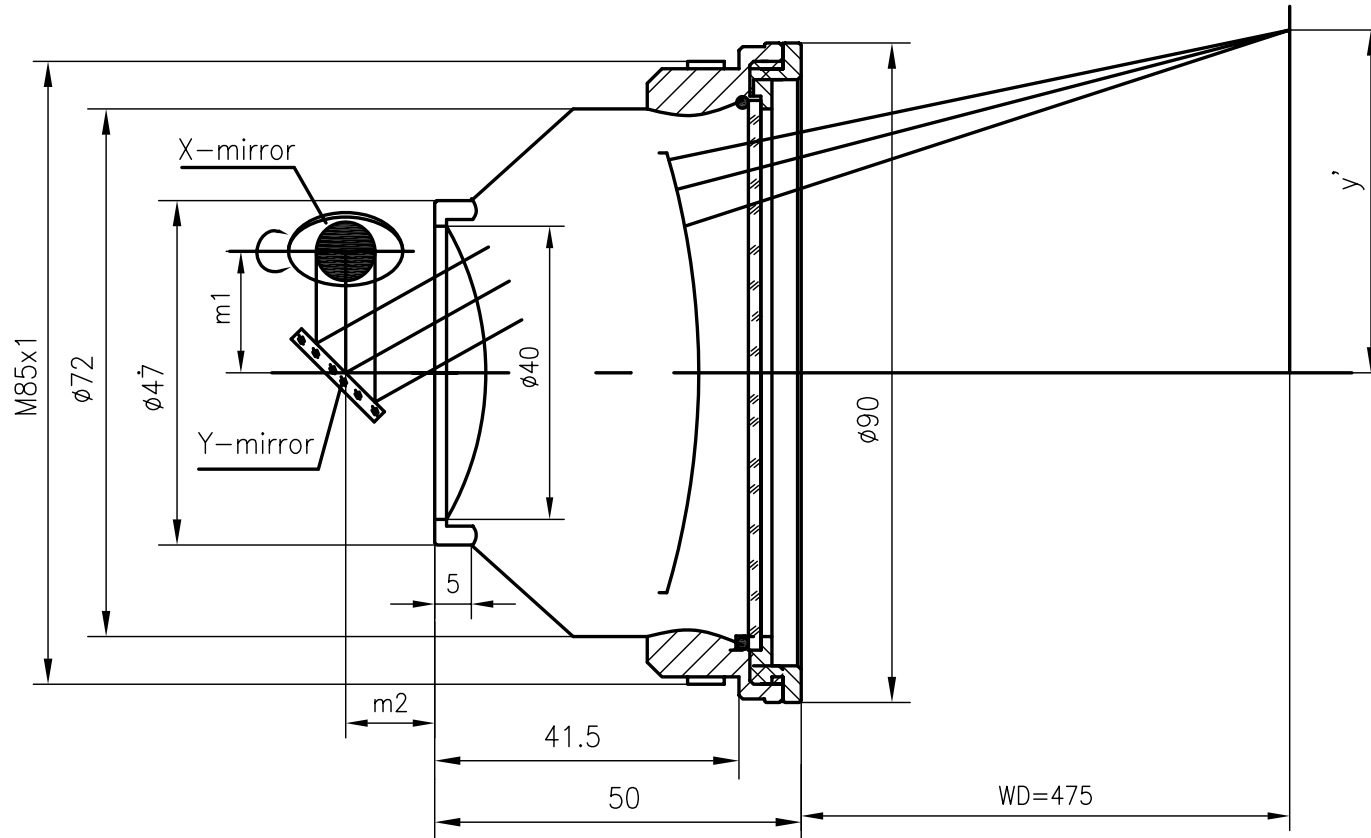

Specification

EFL	420mm
WD	475mm
Wavelength	$\lambda = 355\text{nm}$
scan angle	$\pm 28^\circ$
max scan field	300mm x 300mm
Entrance beam diameter \varnothing	8mm
Center point diameter ($1/e^2$)	34 μm
Edge point diameter ($1/e^2$)	40 μm
mirror distance m1	16-20
mirror distance m2	10-12
Transmission >	97%
Thread	M85x1
With protective window	yes