

F-Theta f=800mm

Drawing No. SH79-1064-560-800-20

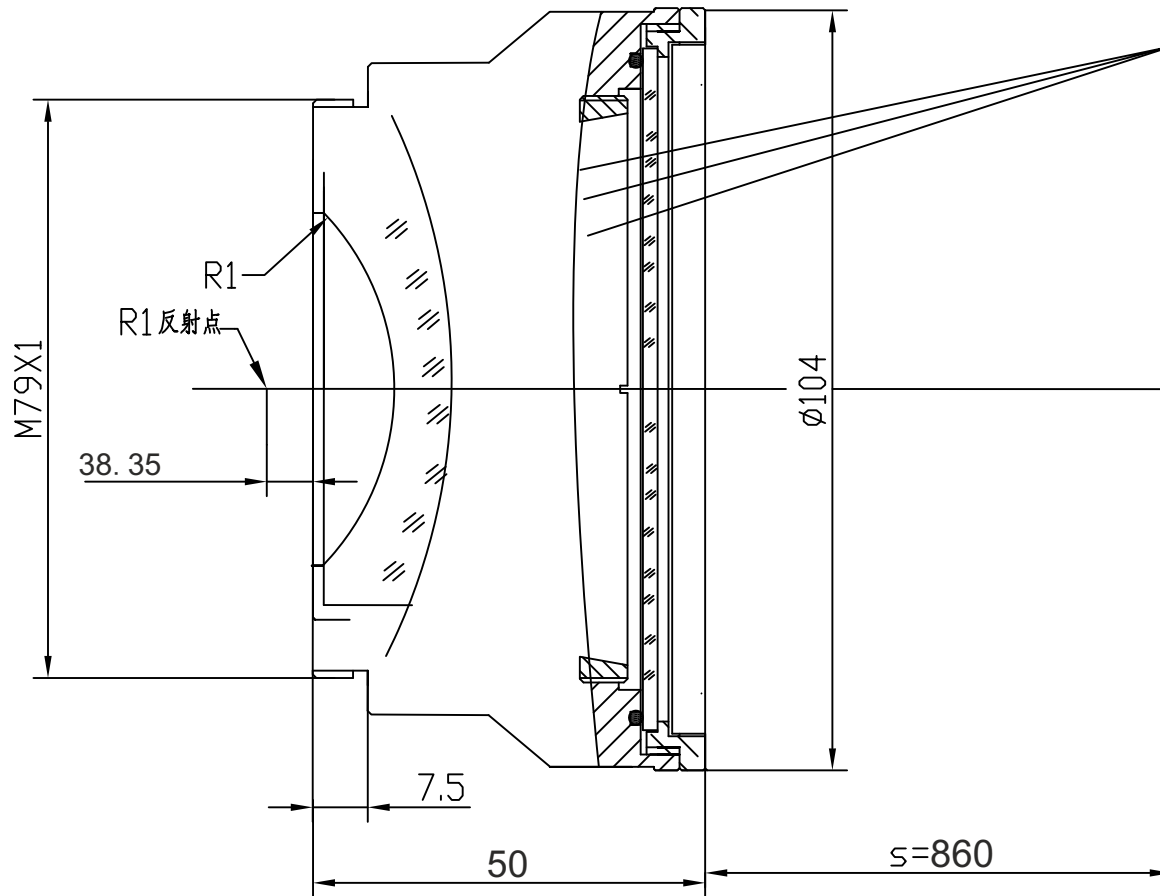

Specification

EFL	800mm
S	860mm
Wavelength	$\lambda = 1064\text{nm}$
scan angle	$\pm 28^\circ$
max scan field	560mm x 560mm
Entrance beam diameter \varnothing	20mm
Center point diameter ($1/e^2$)	78 μm
Edge point diameter ($1/e^2$)	80 μm
mirror distance m1	18
mirror distance m2	24
Transmission >	97%
Thread	M79x1
With protective window	yes